

# EFA circular saws

## Breaking and splitting saws

EFA 85 /DS

EFA 86 /DS

EFA 185 DS/H

EFA 186 DS/B

EFA SK 18 WB/S

EFA SK 23/18

EFA SK 30/18

EFA SK 40 E



## Translation of the original operating instructions

**Schmid & Wezel GmbH.** All rights reserved.

Printed in Germany.

These operating instructions must not be reproduced in whole or in part, used for competitive purposes without our authorisation, or made available to third parties without our consent.

Any changes or amendments to these operating instructions are only allowed to be made by us; otherwise any warranty claim against us will be void.

### **Schmid & Wezel GmbH**

#### **Maschinenfabrik**

Maybachstrasse 2  
75433 Maulbronn / Germany

 +49 7043 1020

 +49 704 310 278

 [efa-verkauf@efa-germany.de](mailto:efa-verkauf@efa-germany.de)

Internet: <http://www.efa-germany.de>

## Table of contents

1	Introduction and general information	2
1.1	Information on the operating instructions	2
1.2	User group	2
1.3	Scope of supply	3
1.4	Intended use	3
1.5	Claims for defects, liability, warranty	4
2	Safety	6
2.1	Safety instructions	6
2.1.1	Other safety signs	7
2.1.2	Warning signs	7
2.1.3	Mandatory instruction signs	7
2.1.4	Prohibition sign	8
2.2	Personal protective equipment	8
2.3	Conduct at the workplace	8
3	Technical description	10
3.1	Technical data	10
3.2	Overview EFA circular saw	12
3.1	Dimensions	14
3.2	Nameplate	16
4	Transport and storage	17
5	Connection and start-up	18
5.1	Initial start-up	18
5.1.1	Spring balancer	18
5.1.2	Electrical connection	19
5.1.3	Water connection	19
6	Handling	20
6.1	Switch operation	20
6.1.1	Switching on	20
6.1.2	Switching off	20
6.2	Working with the circular saw	21
6.2.1	Operation	21
6.2.2	Operational safety	21
7	Assembly	22
7.1	Saw blade change	22
7.2	Sharpening the saw blade	23
7.3	Protective hood and depth stop	23
7.4	Changing the carbon brush	23
8	Cleaning	24
8.1	Daily cleaning after completion of the slaughtering	24
8.1.1	Cleaning the circular saw	24
9	Maintenance and repair	25
9.1	Maintenance	25
9.1.1	Daily maintenance of the circular saw	25
9.1.2	Extended maintenance	25
9.2	Repair by customer service	26
9.2.1	Return	26
10	Waste disposal – recycling	27

# 1 Introduction and general information

**Important!**

**Operating instructions cannot prevent misuse in every case!**

## 1.1 Information on the operating instructions

These operating instructions are part of the technical documentation of the machine and comply with the Machinery Directive.

The machine has been designed and built according to the careful selection of the harmonising standards to be observed as well as other technical specifications.

The operating instructions are intended to describe the operation and handling of the EFA circular saw and provide the necessary safety instructions.

These operating instructions are intended for the machine operator and contain the details of the intended use and important information:

- for safe handling of the machine,
- for maintenance,
- for cleaning.

If the instructions are followed, the EFA circular saw will be operated safely, properly and economically and its operational capability will be maintained.

Observance of these instructions helps to avoid dangers, minimise repair costs and downtimes, and increase the reliability and service life of the machine.

A prerequisite for safe handling and trouble-free operation of the machine is observance of the following:

- the operating instructions,
- the company directives (safety signs and danger warnings),
- the legal provisions on occupational safety,
- the applicable laws and regulations.

These operating instructions must always be kept accessible at the machine for all work to be carried out.

**Note!**

If the existing operating instructions have been damaged or lost, you can request a replacement by stating: machine designation, part number, serial number and year of production, see section 3.2 Nameplate.

If you have any questions, or if you cannot solve a problem with the help of these operating instructions, please contact our Service department.

## 1.2 User group

Only instructed and/or trained personnel over 16 years of age are allowed to set up or operate the EFA circular saw. Furthermore, it is imperative that everyone working with and on the machine has read and understood the operating instructions, and observes them.

The operation of the circular saw by persons who are under the influence of alcohol, medication, or drugs is strictly prohibited.

**Instructed person**

Persons over 16 years of age who have been instructed and trained by a qualified person (specialist) in the tasks assigned to them and about possible dangers in the event of improper behaviour, as well as in the handling of the necessary protective devices and protective measures, are considered to be instructed persons.

### Trained person (specialist personnel)

Persons who have obtained a professional qualification and have demonstrated this by checking the results or passing an examination are considered to be trained persons.

## 1.3 Scope of supply

Upon receipt of the delivery, check immediately whether the scope of supply corresponds to the accompanying documents.

Submit a complaint in the event of:

- apparent transport damage immediately to the supplier,
- apparent defects/missing items, to **Schmid & Wezel GmbH**.

These operating instructions describe the **EFA circular saw** with all possible options.

Options are not necessarily included in the scope of supply and can only be retrofitted to a limited extent.

## 1.4 Intended use

**Danger!**



**Never point the device at people!**



**Wear eye protection such as protective goggles when working!**

**Danger!**



**Never reach into the cutting area of the saw blade, you could injure yourself!**

### Areas of application

- **EFA 85, EFA 85 DS, EFA 185 DS, EFA 185 H**  
These breaking saws are designed for medium to heavy breaking operations in medium sized and large plants. These models are suitable for breaking and quartering in the hanging of halves of beef.
- **EFA 86, EFA 86 DS, EFA 186, EFA 186 DS, EFA 186 B**  
These breaking saws are designed for medium to heavy breaking operations in medium sized and large plants. These models are suitable for the breaking of halves of beef and pork in hanging and lying position; can be used on breaking belts or tables.
- **EFA SK 18 WB, EFA SK 18 S, EFA SK 18 S AE**  
This breaking saw is used for breaking cattle, calves, pigs and sheep.
- **EFA SK 23/18**  
This breaking saw is used for breaking cattle, calves, pigs and sheep.
- **EFA SK 30/18**  
This model is particularly suitable for quartering halves of beef due to its performance and the 300 mm saw blade.
- **EFA SK 40 E**  
This splitting saw is designed for light to medium breaking operations, especially for halving hogs and sows in medium sized and large plants.

These machines are not equipped for a different type of use. Should the user desire to use the equipment for a different purpose than intended, please contact **Schmid & Wezel GmbH (S&W)**. For all other types of use, the user must be advised of the inherent accident hazard and increased wear.

**In the event of non-compliance, the liability shall be borne by the user alone.**

The circular saw is only allowed to be used:

- in a fully functional and perfect technical state, in line with the intended use, in consideration of all of the safety- and hazard-relevant aspects,
- with properly functioning safety devices,
- with the equipment approved by the manufacturer.

**Do not use materials harmful to health.**

If, contrary to the intended use, materials harmful to health are to be processed then **Schmid & Wezel GmbH** must be informed in writing about the planned use and the protective measures taken by the customer/operating company.

The customer/operating company is solely responsible for suitable protective measures (e.g. extraction devices, respiratory protection, protective suits, etc.) and company directives.

If the EFA circular saw is not used as intended or is modified without the approval of **Schmid & Wezel GmbH**, persons could be injured and the machine damaged.

**The operating permit is invalidated.**

The intended use includes in particular that you:

- Observe the operating instructions and company directives,
- Observe maintenance instructions and intervals,
- Immediately rectify any faults that impair safety,
- Do not operate the circular saw if safe working with it is not possible,
- Do not make any structural changes to the circular saw without authorisation.

**Danger!**



**The circular saws can be hazardous if they are used by untrained persons, in an improper manner, or for purposes that are not in line with the intended use.**

**Residual hazards**

As the circular saw is intended for industrial use on carcasses, there is a possibility of injury or, in case of gross misuse, of **fatal** injury. Therefore, in case of misuse, the possibility of immediate death or death by blood loss must be expected.

Consequently, always pay attention to the correct handling of the machine.

There is an injury hazard, especially in the uncovered area of the saw blade. Remain focused and act with caution when working. Wear personal protective equipment

## 1.5 Claims for defects, liability, warranty

Warranty and liability claims for personal injury and damage to property are excluded in particular in the following cases:

- Improper use or unsuitable use,
- Improper transport or storage,
- Improper assembly and/or initial start-up,
- Improper operation (operating errors),
- Disregarding of operating instructions/company directives,
- Faulty or negligent handling,
- Improper maintenance/repair,
- Unsuitable equipment or spare parts that are not approved by **Schmid & Wezel GmbH Maschinenfabrik**,
- Natural wear and tear,
- Improper or unprofessional rectification of defects by the customer/operating company or third parties,
- Unauthorised structural changes to the machine without written permission from **Schmid & Wezel GmbH**,
- Chemical, electrochemical or electrical influences – unless they are the responsibility of **Schmid & Wezel GmbH**.

**Liability**

The manufacturer accepts no liability for accidents, machine damage and consequences of machine failure resulting from failure to observe the operating instructions. In addition, the local accident prevention regulations and general safety regulations for the area of application of the machine apply.

### Limitation of liability

All technical information, data and instructions for the operation of the machine contained in the operating instructions are up to date at the time of delivery. They are provided to the best of the manufacturer's knowledge, taking into account previous experience and knowledge. The manufacturer reserves the right to make technical modifications in the course of further development of the machine described in these operating instructions. No claims can therefore be derived from the information, figures and descriptions in these operating instructions. The manufacturer shall be liable for any errors or omissions within the scope of the warranty obligations entered into in the contract, to the exclusion of further claims.

Claims for damages are excluded, irrespective of the legal basis on which such claims are derived. Only the text of the **original operating instructions** is authoritative.

The textual and graphical representation in the operating instructions does not necessarily correspond to the scope of supply or a spare parts order. Illustrations in these instructions are not to scale.

### Technical changes

The manufacturer **Schmid & Wezel GmbH** reserves the right to make technical changes within the scope of improving the usage properties and further development without prior notice. Figures are for basic understanding and could differ from the actual design of the system.

### Copyright

The manufacturer reserves the copyright to these operating instructions. These operating instructions are intended for assembly, operating, maintenance and monitoring personnel.

Transferring the operating instructions to third parties without the written consent of the manufacturer **Schmid & Wezel GmbH** is not permitted. Duplication in any kind and form – in whole or in part – as well as the use and/or communication of the contents are not permitted without written declaration of the manufacturer.

#### Note!



All content, texts, drawings, pictures and other representations are protected by copyright and are subject to industrial property rights. Any improper use may be punishable!

## 2 Safety

Everyone who is involved in the installation, start-up, operation, set-up, equipping and maintenance of the machine in the operating company must have read and understood the operating instructions, in particular the "Safety" chapter.

Safe operation of the machine is only guaranteed if:

- Unauthorised persons are kept away from the working area of the machine,
- Safe working with awareness of the dangers involved is regularly checked in accordance with the operating instructions,
- No working methods are employed that could compromise safety,
- Malfunctions in the machine are eliminated immediately,
- Maintenance work is carried out regularly.

### Important!



The operating instructions must be accessible at all times during the entire period of use of the machine for the operating, maintenance and cleaning personnel.

Therefore, always keep these operating instructions close to the machine.

### First aid!

### Important!



In the event of an accident, provide **FIRST AID!**





- Keep calm!
- Remove injured persons from the danger area without endangering yourself!
- Inform other employees (first-aiders, paramedics) or request help!

### 2.1 Safety instructions

During the use of the machine, dangers could arise in certain situations or through certain behaviour.



The measures described to protect against dangers must be observed.

The safety instructions are identified as shown in the following tables (pictograms).

Symbol/ pictogram	Signal word	Damage/ injury to . . .	Definition	Possible consequences of disregarding the safety instructions
	<b>Danger</b>	Persons	Imminent danger	Death, serious bodily injury or substantial damage to property
	<b>Warning</b>	Persons	Potentially dangerous situation	Death or serious bodily injury could occur
	<b>Caution</b>	Persons	Less dangerous situation	Slight or minor injuries
	<b>Attention</b>	Property	Potentially harmful situation	Damage to the product or its environment
	<b>Information</b>	-	Application tips and other important/useful information and notes	No dangerous/harmful situation







### 2.1.1 Other safety signs







Symbol	Meaning
	<b>Mark of conformity!</b> The machine complies with the applicable regulations of the EC Machinery Directive.
	<b>Recyclable materials!</b> Ensure that the materials are recycled properly!

### 2.1.2 Warning signs

Warnings and symbols used in the operating instructions and documentation are intended to help you to recognise and assess the dangers more easily.

Symbol	Meaning
	<b>Warning: Dangerous electrical voltage!</b> Touching live parts can result in immediate death. Covers or cabinets marked with this sign are only allowed to be opened by qualified electricians after the machine has been switched off.
	<b>Warning: Sharp cutting tool!</b> Contact with the running cutting tool will lead to extremely severe cutting injuries involving permanent or even fatal injury. Ensure that a sufficient safety distance is maintained. Contact with the stationary cutting tool could lead to severe cutting injuries involving permanent injury. Wear safety gloves. Ensure that a safety distance is maintained.
	<b>Warning: Hand injuries!</b> There is a danger of hands being pinched, pulled in or otherwise injured. Keep your hands away from places that bear this warning sign!
	<b>Warning: Noise with high sound pressure level!</b> If the sound pressure level at the workplace is above 85 dB(A). Remaining for a relatively long period can cause permanent hearing damage. Only enter the area if wearing the correct hearing protection.
	<b>Warning of hot surface!</b> It is not always possible to notice the presence of hot machine parts, containers or materials, as well as hot liquids. If such a safety sign is affixed to a component, care must be taken. Do not touch hot surfaces without protective gloves.

### 2.1.3 Mandatory instruction signs

Symbol	Meaning
	<b>General mandatory instruction sign!</b> Observe company directives, notes in operating instructions and generally applicable safety regulations.
	<b>Wear cut-resistant gloves!</b> Cutting injuries possible. Provide information about suitable cut-resistant gloves.
	<b>Use safety shoes!</b> Safety shoes form part of the personal protective equipment and provide protection for the health of the worker. They prevent accidents and injuries such as crushing by heavy objects.
	<b>Wear a protective helmet!</b> Head injuries are possible due to objects falling, tipping over or being thrown out, or due to swinging loads; bumping into obstacles also represents a danger. A suitable protective helmet must always be worn on the head when in the indicated area.
	<b>Wear protective goggles!</b> Eye injuries (loss of vision) possible when working due to flying solid objects.
	<b>Wear hearing protection!</b> If the continuous sound pressure level of the machine/system is above 85 dB(A), hearing protection must be worn to prevent permanent hearing damage.
	<b>Wear protective clothing!</b> Protection against contact with auxiliary or working equipment. Find out about suitable protective clothing.

### 2.1.4 Prohibition sign

Symbol	Meaning
	<p><b>General prohibition sign!</b> The red signal border/prohibition stripe indicates an immediate danger and is overlaid diagonally over the self-explanatory symbol. The general prohibition sign must always be used in conjunction with another sign.</p>

## 2.2 Personal protective equipment

Some work requires protective equipment.

This protective equipment must be made available to the operator.

Lifecycle phase	Protective equipment
<b>Transport</b>	<ul style="list-style-type: none"> <li>▪ Protective gloves</li> <li>▪ Safety shoes</li> </ul>
<b>Assembly, start-up and maintenance</b>	<ul style="list-style-type: none"> <li>▪ Cut-resistant gloves</li> <li>▪ Safety shoes</li> <li>▪ Protective goggles</li> <li>▪ Hearing protection</li> <li>▪ Hairnet for long hair</li> </ul>
<b>Operation</b>	<ul style="list-style-type: none"> <li>▪ Hairnet for long hair</li> <li>▪ Cut-resistant gloves</li> <li>▪ Protective goggles</li> <li>▪ Hearing protection</li> <li>▪ Safety shoes</li> <li>▪ Protective clothing</li> </ul>
<b>Storage</b>	<ul style="list-style-type: none"> <li>▪ Protective gloves</li> <li>▪ Safety shoes</li> </ul>
<b>Disposal</b>	<ul style="list-style-type: none"> <li>▪ Protective gloves</li> <li>▪ Safety shoes</li> </ul>

## 2.3 Conduct at the workplace

The workplaces must be designed in such a way that each employee has at least 1.5 m<sup>2</sup> of freedom of movement. Ensure proper lighting of the workplace (at least 500 lux).

No other workplace should protrude into this area, otherwise there is an injury hazard due to the actions carried out with circular saw.

The floor must minimise the danger of slipping on wet, greasy or dirty surfaces.

The workplace must comply with local hygiene and workplace regulations.

- Keep your workplace tidy and in good working condition. A cluttered or messy workplace can lead to accidents.
- Take environmental influences into account.
- Keep other persons away from your workplace. Focus on the job in hand when working.
- Do not use the EFA circular saw when you are tired and/or unfocused.
- Store the circular saw in a safe manner. Store unused devices in a dry place.
- Avoid wearing loosely fitting items of clothing and jewellery that can be caught by moving parts. Wear sturdy shoes during your work. Always wear a hairnet!
- Ensure that your workplace has a correct, ergonomic set-up and make sure that you are standing securely.
- Only use original EFA saw blades. Follow the instructions listed under Saw blade change. See also *section 7.1 Saw blade change*.
- Do not leave any tool keys connected. Check that all keys have been removed before switching on.
- Look after your tools with care. Use only sharp and undamaged saw blades so that you can work better and more safely.
- Only use genuine EFA accessories/spare parts.
- Never drill into the motor housing. Use adhesive labels to identify the device.
- Changes and modifications to the machine are not permitted and, if any such changes are made, **S&W's** guarantee and liability shall be invalidated.

The use of other equipment, accessories or spare parts can endanger you and other persons.

Non-compliance will void the warranty.









## 3 Technical description





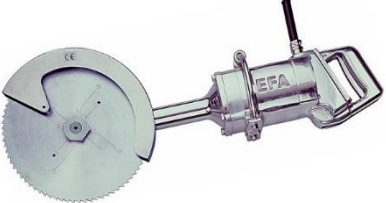

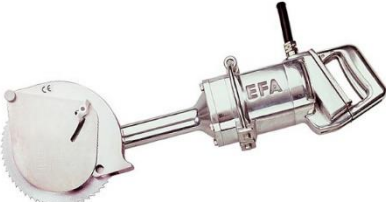

### 3.1 Technical data

EFA circular saws	Operating voltage	Frequency	Current consumption	Motor power max.	Rotational speed	Connection cable	Protection Class	Type of protection	Saw blade	Depth of cut	Water consumption	SPL - sound pressure level	SWL - sound power level	Vibration characteristic value	K - correction factor	Weight	Machine No.
	V	Hz	A	W	min <sup>-1</sup>	m	-	-	Ø mm	mm	l/min	L <sub>pA</sub> dB(A)	L <sub>WA</sub> dB(A)	a <sub>hd</sub> [m/s <sup>2</sup> ]	K [m/s <sup>2</sup> ]	kg	
<b>EFA 85</b>	400	50	3.5	1500	1150	4	I	IP 65	300	100	-	74	85	0.644	0.096	16	110886300
<b>EFA 85</b>	400	60	3.5	1500	1350	4	I	IP 65	300	100	-	74	85	0.644	0.096	16	110886343
<b>EFA 85</b>	208	60	7.3	1500	1350	4	I	IP 64	300	100	-	74	85	0.644	0.096	16	110886334
<b>EFA 85</b>	115	50	12.1	1500	1150	4	I	IP 65	300	100	-	74	85	0.644	0.096	16	110886305
<b>EFA 85</b>	42	50	33	1500	1150	4	III	IP 65	300	100	-	74	85	0.644	0.096	16	110886302
<b>EFA 85</b>	42	50	33	1500	1150	4	III	IP 65	300	100	-	74	85	0.644	0.096	16	110886307
<b>EFA 85 DS</b>	400	50	3.5	1500	1150	4	I	IP 65	300	100	-	71	82	0.851	0.179	17	110886308
<b>EFA 85 DS</b>	42	50	33	1500	1150	4	III	IP 65	300	100	-	71	82	0.851	0.179	17	110886304
<b>EFA 185</b>	400	50	3.5	1500	1150	4	I	IP 65	300	100	-	75	86	0.637	0.085	17	110886310
<b>EFA 185</b>	208	60	6.7	1500	1350	4	I	IP 65	300	100	-	75	86	0.637	0.085	17	110886319
<b>EFA 185</b>	42	50	33	1500	1150	4	III	IP 65	300	100	-	75	86	0.637	0.085	17	110886312
<b>EFA 185 H</b>	400	50	3.5	1500	1150	4	I	IP 65	300	100	-	77	88	0.876	0.098	19	110886311
<b>EFA 185 H</b>	42	50	33	1500	1150	4	III	IP 65	300	100	-	77	88	0.876	0.098	19	110886313
<b>EFA 86</b>	400	50	3.5	1500	1150	5	I	IP 65	230	15-75	-	71	82	0.446	0.018	16	110886320
<b>EFA 86</b>	208	60	7.3	1500	1350	5	I	IP 65	230	15-75	-	71	82	0.446	0.018	16	110886336
<b>EFA 86</b>	42	50	33	1500	1150	5	III	IP 65	230	15-75	-	71	82	0.446	0.018	16	110886322
<b>EFA 86</b>	42	50	33	1500	1150	5	III	IP 65	230	15-75	-	71	82	0.446	0.018	16	110886327
<b>EFA 86 DS</b>	400	50	3.5	1500	1150	5	I	IP 65	230	15-75	-	67	78	1.103	0.082	17	110886328
<b>EFA 86 DS</b>	42	50	33	1500	1150	5	III	IP 65	230	15-75	-	67	78	1.103	0.082	17	110886324
<b>EFA 186</b>	42	50	33	1500	1150	5	III	IP 65	230	15-75	-	72	83	0.847	0.039	17	110886337
<b>EFA 186</b>	400	50	3.5	1500	1150	5	I	IP 65	230	15-75	-	72	83	0.847	0.039	17	110886330
<b>EFA 186</b>	42	50	33	1500	1150	5	III	IP 65	230	15-75	-	72	83	0.847	0.039	17	110886332

<b>EFA SK 18 S</b>	230	50 / 60	5.5	1200	2000	2.8	I	IP 65	180	15-65	-	71	82	0.886	0.088	9.6	110885355
<b>EFA SK 18 S AE</b>	230	50 / 60	5.5	1200	2000	2.8	I	IP 65	180	24-65	-	72	83	0.975	0.019	9.6	110885356
<b>EFA SK 18 WB</b>	230	50 / 60	4.55	1020	1650	3.5	I	IP 24	180	15-65	-	79	90	0.857	0.056	6.7	110885310
<b>EFA SK 18 WB</b>	230	50 / 60	4.55	1020	1650	3.5	I	IP 24	180	15-65	-	79	90	0.857	0.056	6.7	110885340
<b>EFA SK 18 WB</b>	115	50 / 60	9.2	1020	1650	3.5	I	IP 24	180	15-65	-	79	90	0.857	0.056	6.7	110885320
<b>EFA SK 18 WB</b>	42	50 / 60	25.2	1020	1650	3.5	III	IP 24	180	15-65	-	79	90	0.857	0.056	6.7	110885330
<b>EFA SK 23/18</b>	230	50 / 60	8.4	1800	1350	3.5	I	IP 24	230	15-75	-	85	96	5.747	0.26	9.8	110890306
<b>EFA SK 23/18</b>	42	50 / 60	46	1800	1350	3.5	III	IP 24	230	15-75	-	85	96	5.747	0.26	9.8	110890307
<b>EFA SK 30/18</b>	230	50 / 60	8.4	1800	1350	3.5	I	IP 24	300	100	-	88	99	3.154	0.246	11	110890406
<b>EFA SK 30/18</b>	42	50 / 60	46	1800	1350	3.5	III	IP 24	300	100	-	88	99	3.154	0.246	11	110890407
<b>EFA SK 40 E</b>	400	50	5	2500	1400	6	I	IP 44	400	140	7	77	88	1.031	0.151	42	110888206
<b>EFA SK 40 E</b>	115	50	17	2500	1400	6	I	IP 44	400	140	7	77	88	1.031	0.151	42	110888226
<b>EFA SK 40 E</b>	42	50	45	2500	1400	6	III	IP 44	400	140	7	77	88	1.031	0.151	47	110888216
<b>EFA SK 40 E</b>	600	60	3.3	2500	1400	6	I	IP 44	400	140	7	77	88	1.031	0.151	42	110888266
<b>EFA SK 40 E</b>	440-460	60	4.45-4.26	2500	1400	6	I	IP 44	400	140	7	77	88	1.031	0.151	42	110888246
<b>EFA SK 40 E</b>	415	60	4.6	2500	1400	6	I	IP 44	400	140	7	77	88	1.031	0.151	42	110888236
<b>EFA SK 40 E</b>	230	60	8.5	2500	1400	6	I	IP 44	400	140	7	77	88	1.031	0.151	42	110888256
<b>EFA SK 40 E</b>	42	60	45	2500	1400	6	III	IP 44	400	140	7	77	88	1.031	0.151	47	110888217

### 3.2 Overview EFA circular saw

EFA circular saw	Usage	Application
<p><b>EFA 85</b> <b>EFA 85 DS</b></p> 		<p><b>Breaking saw</b>                      2-hand control:                      Powerful breaking saw with centrifugal power brake for halves of beef; for medium and large sized plants.</p>
<p><b>EFA 86</b> <b>EFA 86 DS</b></p> 		<p><b>Breaking saw</b>                      2-hand control:                      Powerful breaking saw with centrifugal power brake for halves of hogs; for medium and large sized plants.</p>
<p><b>EFA 185</b> <b>EFA 185 DS</b> <b>EFA185 H</b> <b>EFA 185 H DS</b></p> 		<p><b>Breaking saw</b>                      Powerful breaking saw with centrifugal power brake and extended gear head, for halves of beef; for medium and large sized plants.</p>
<p><b>EFA 186</b> <b>EFA 186 DS</b> <b>EFA 186 B</b></p> 		<p><b>Breaking saw</b>                      Powerful breaking saw with centrifugal brake and long gear head, for hogs; for medium and large plants.</p>

<p><b>EFA SK 18 WB</b>  <b>EFA SK 18 S</b>  <b>EFA SK 18 S AE</b></p> 		<p><b>Breaking saw</b>                  The handy breaking saw for butcher's shops and medium-sized plants.</p>
<p><b>EFA SK 23/18</b></p> 		<p><b>Breaking saw</b>                  Breaking saw for halves of hogs; for medium and large sized plants.</p>
<p><b>EFA SK 30/18</b></p> 		<p><b>Breaking saw</b>                  Breaking saw for halves of beef; for medium and large sized plants.</p>
<p><b>EFA SK 40 E</b></p> 		<p><b>Splitting saw</b>                  2-hand control:                  High cooling and water connection for cleaning and cooling the saw blade.</p>

### 3.1 Dimensions

The following figures give you an overview of the dimensions of the EFA circular saws.

#### EFA 85, EFA 85 DS

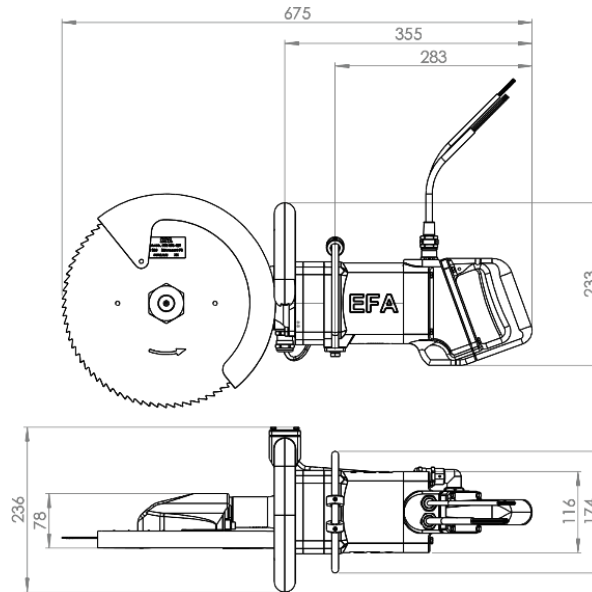

#### EFA 86, EFA 86 DS

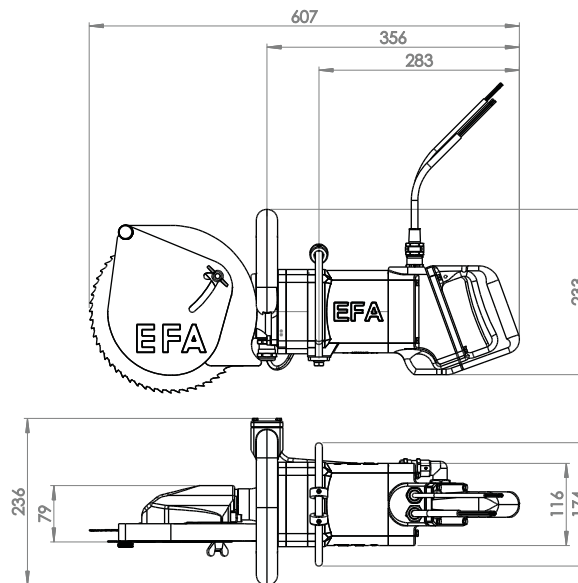

#### EFA 185, EFA 185 DS, EFA 185 H, EFA 185 H DS

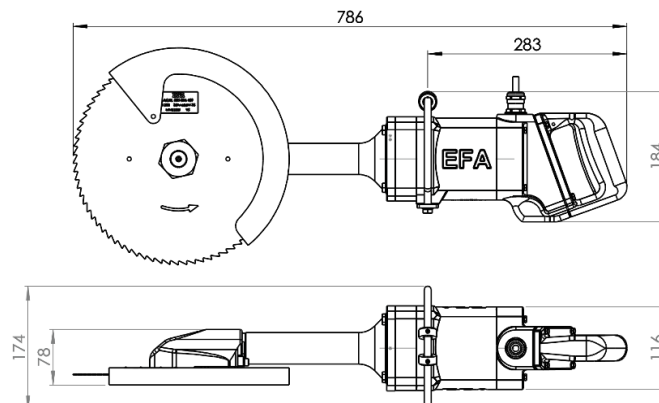

**EFA 186, EFA 186 DS, EFA 186 B**

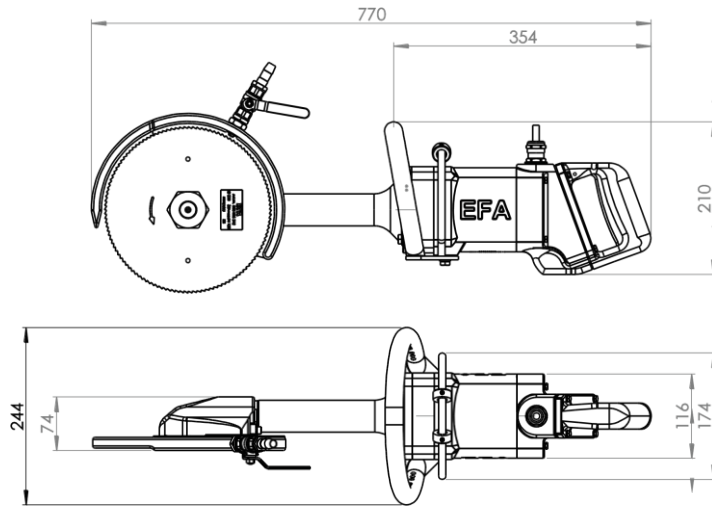

**EFA SK 18 WB, EFA SK 18 S, EFA SK 18 S AE**

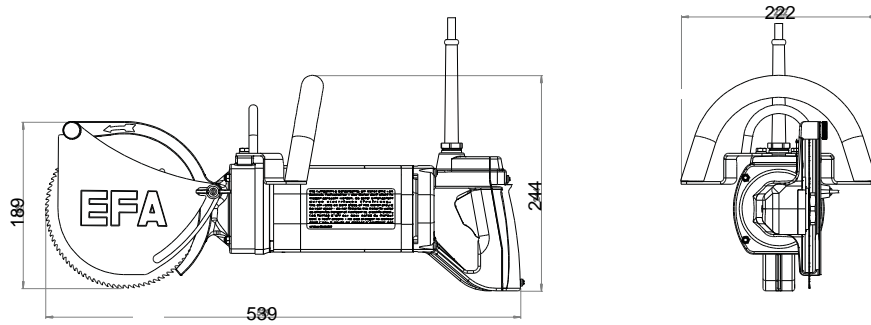

**EFA SK 23/18**

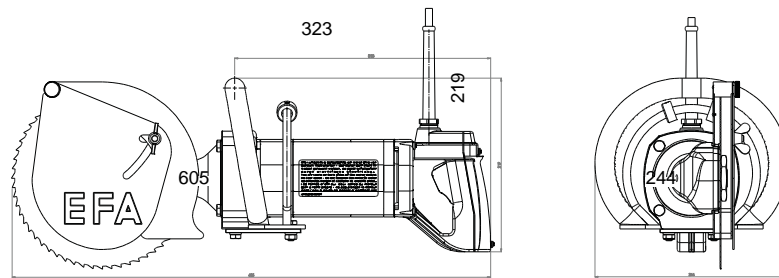

**EFA SK 30/18**

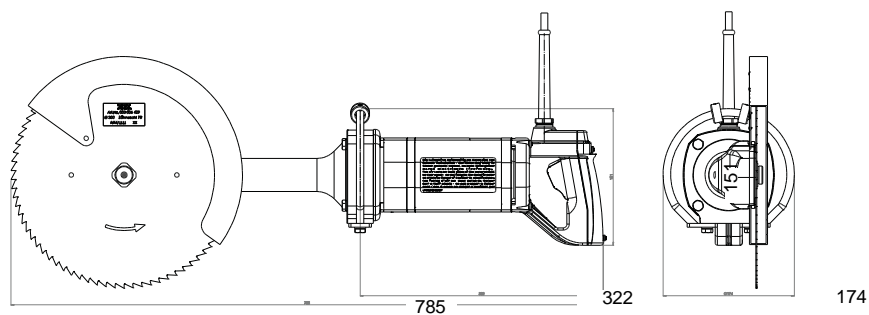



**EFA SK 40 E**

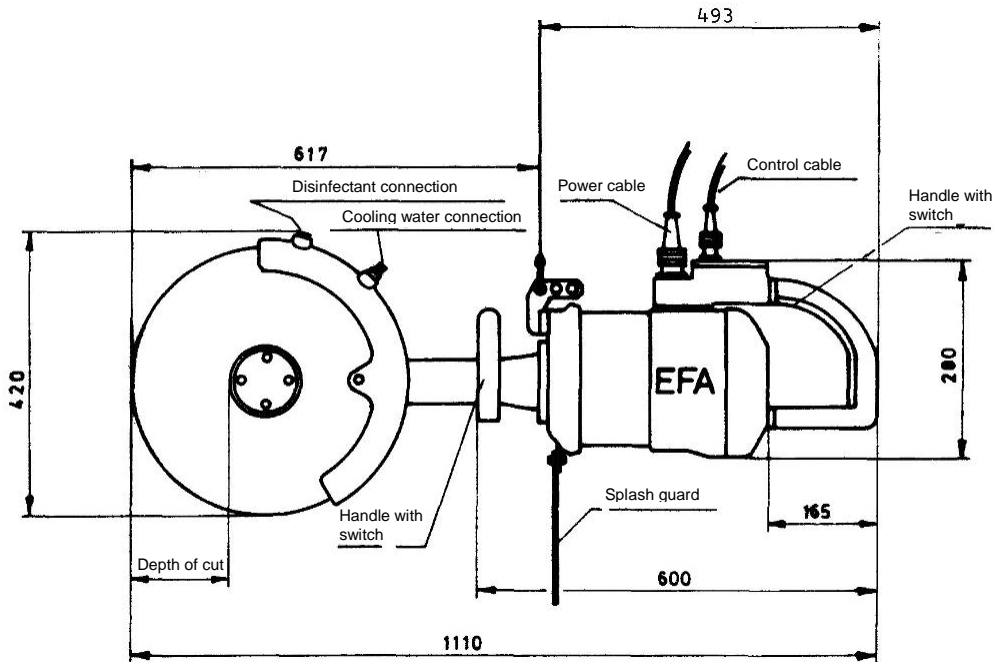

### 3.2 Nameplate

The nameplate is attached to the machine and contains information on the machine performance. The following figure shows an example of the nameplate for the EFA machines.

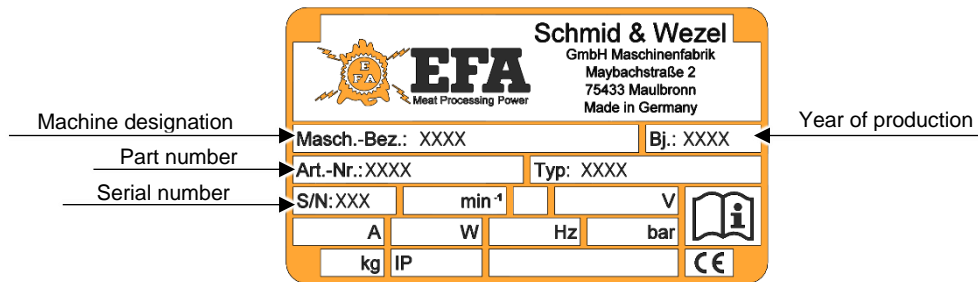

---

## 4 Transport and storage

---

The machine has been tested and carefully checked in our factory before shipment.

The test ensures that the machine is working properly.

Despite all care taken, there is a possibility that the machine could be damaged during transport.

Therefore, check the machine for possible transport damage when unpacking it.

### **Unpacking the machine**

- Remove all packaging materials and dispose of them in a professional and environmentally friendly manner.
- Check the machine for possible transport damage.
- Information on *disposal and recycling* can be found in *section 10*.

### **Storage of the machine**

For safe storage of the machine, it is essential to observe the following instructions:

- Only store the machine in a dry, ventilated room.
- Only store the machine in a clean and dry condition.
- Protect the machine from corrosion.

## 5 Connection and start-up

### 5.1 Initial start-up

**Danger!**



**Voltage!**  
Installation work is only allowed to be carried out by authorised specialist personnel.  
Only connect the saw to the mains when it is switched off!

**Caution!**



**Tripping hazard!**

We recommend that the lines are led away upwards.  
Lines that run along the floor can be a tripping hazard for the operator!

**Warning!**



Wear eye protection or protective goggles and safety shoes when working!

When the saw is not in use, place it in such a way that there is no accidental contact with the sharp saw blade. This can lead to injuries.

#### 5.1.1 Spring balancer

The machine must always be operated in combination with a weight relief device (spring balancer), see Fig. 5.1 and Fig. 5.2.

The spring balancer is secured with a safety chain (2), see Fig. 5.3 Fine-tuning of the spring balancer. This must be secured in a fixed position independent of the suspension of the spring balancer.

Use a trolley to attach the spring balancer to a higher element above the workplace or to the ceiling.

**Danger!**



**Do not come into contact with the sharp saw blade.**

**Danger!**



**Due to the weight, there could be a hazard due to the machine slipping or falling when the weight relief device is attached or detached.**

**Danger!**



**When hooking in the cable of the spring balancer, the spring loaded rope can whip around if the snap hook is not properly hooked. Please note that if the rope rebounds when unloaded, it is very dangerous for people. The spring will also be irreparably damaged. The maximum load specified on the nameplate must not be exceeded.**

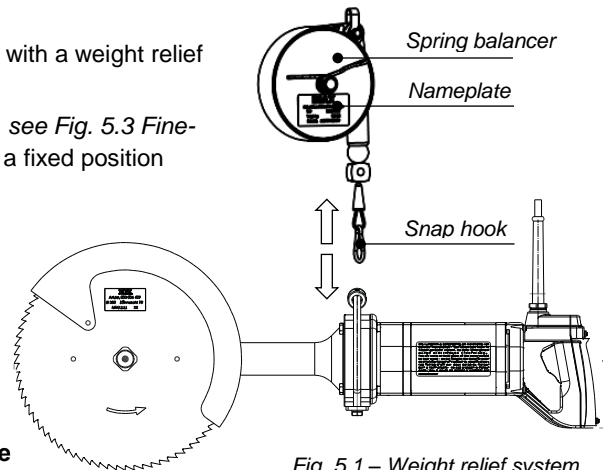

Fig. 5.1 – Weight relief system (spring balancer)

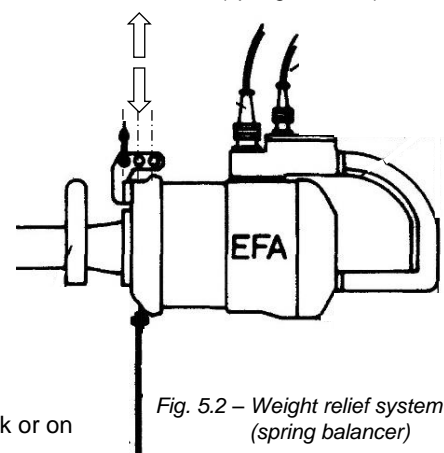

Fig. 5.2 – Weight relief system (spring balancer)

Also make sure that the machine does not jam either on the snap hook or on the hook of the circular saw.

Be careful!

### Adjustment of the spring balancer

The fine-tuning of the spring balancer is carried out via the plus/minus (+/-) screw on its housing (1).

- To do this, turn the screw in the direction of minus (-) until the device is freely suspended and balanced (with the tension spring) at working height.

If it is not possible to pull out, the spring balancer is blocked and a new adjustment is necessary.

- Turn the screw in the plus direction (+) until pulling out is possible and start the fine adjustment again.

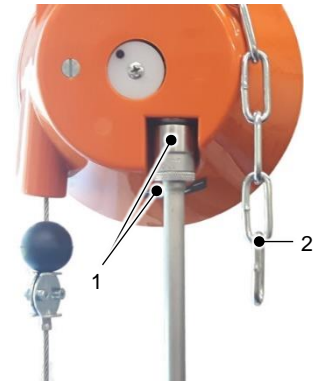

Fig. 5.3 – Fine-tuning of the spring balancer

### 5.1.2 Electrical connection

The saw is operated with electrical power. It must be connected by a qualified electrician in accordance with the legal regulations and those of the local energy supply companies.

- For electrical machines, a fuse must be provided on the operating side.  
If the operating voltage does not correspond to a safety extra-low voltage, a residual current circuit breaker (RCCB) must be installed on the operating side.
- Before connecting the safety isolating transformer on the primary side (only for safety extra-low voltage), the connection data of the transformer must be observed. Furthermore, the existing power system type must be taken into account. Fuse protection of the transformer must be provided on the operating side.
- The cable cross-sections must be dimensioned accordingly for the electrical connection of the connecting cable between the safety isolating transformer and the control (only with safety extra-low voltage).
- The connecting line of the saw must be connected according to the electrical circuit diagram supplied.
- When starting up the saw, check the direction of rotation of the motor.
- The saw has been designed and built according to the Machinery Directive 2006/42/EC.  
Unauthorised changes and modifications, especially to the safety devices of the saw, are not permitted for reasons of operational safety and, if any such changes are made, the manufacturer's guarantee and liability shall be invalidated.

### 5.1.3 Water connection

#### EFA SK 40 E

There is a cold water connection available.

The saw blade cooling/saw blade rinsing is controlled by a manual valve.  
Instead of the manual valve (tap), a magnetic valve can be installed.

## 6 Handling

### 6.1 Switch operation

**Important!**



The circular saw must not be switched on before the operator has read these operating instructions and the saw has been connected correctly!

**Danger!**



**The saw blade must be correctly mounted and firmly seated.**

#### 6.1.1 Switching on

**Danger!**



**Ensure that the saw is switched off prior to connecting it to the plant network.**

Before switching on, the following points must be checked without fail! An early failure of the saw blade as well as problems in the slaughtering process can thus be avoided to a large extent.

Before switching on, check that:

- the circular saw is operational;
- the saw blade is correctly inserted;
- the suspension (spring balancer) is correctly mounted and is operational;
- a sharp saw blade was mounted directly before starting work, see section 7.1.2 *Installation of saw blade*;
- the general safety instructions have been taken into account, see chapter 2 *Safety*.

The machine can be equipped with one handle (A) and one switching handle (B) or with two switching handles (B – C).

To switch on, press the switch, see Fig. 6.1.

**EFA SK 40 E** – see Fig. 6.2 –

The machine is equipped with an ON/OFF rotary knob (D) and a two-hand safety control.

- 1) Hold the saw securely.
- 2) Safety device (D) at ready = ON mark at **red dot**.
- 3) Press both switches (B + C) at the same time, within 0.3 s, to start the saw.

#### 6.1.2 Switching off

- 1) Release the switch to switch off.
- 2) The switch switches off automatically due to the return spring.

**EFA SK 40 E**

- 1) Release the switch.
- 2) Safety device (D) at rest position = OFF mark at **red dot**.

The saw blade can be switched on and off at any time.

If one switch is released during operation, both switches must be released again and operated simultaneously.

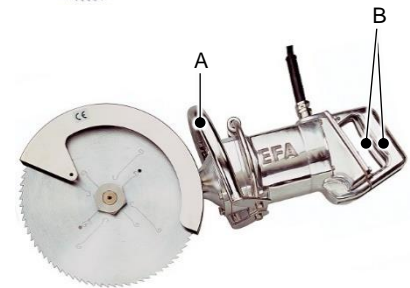
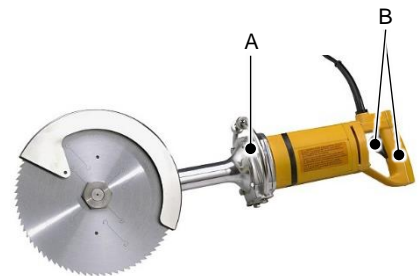

Fig. 6.1 – Switch operation

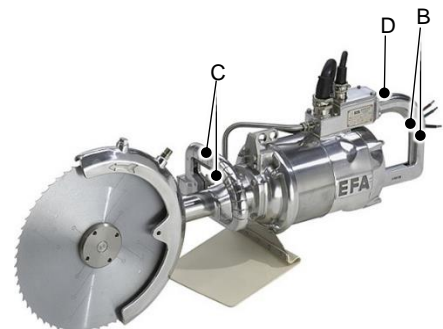

Fig. 6.2 – Switch operation

**Important!**



The saws have an electronic run-down brake and must be held with both hands for the run-down phase of 3 seconds!

## 6.2 Working with the circular saw

**Danger!**



**Never reach into the cutting area of the running saw blade, otherwise you could cut off limbs!**

**Danger!**



**Never work without a protective hood, or with a defective protective hood!**

**Warning!**



Wear eye protection or protective goggles when working!  
Hearing protection must be worn during continuous operation!



Fig. 6.3 – Protective hood

### 6.2.1 Operation

Before use, check that the operating data of the mains and the device match up.

- 1) **EFA 86 – EFA 186 – EFA SK 23/18**  
Adjust the depth of cut using the wing nut/depth stop (A).
- 2) Hold the circular saw securely by both handles and switch it on, see section 6.1.1 *Switching on*.
- 3) Guide it into the piece of meat while it is running.  
Kick-back can occur when touching on bone.
- 4) Only remove the saw from the piece of meat while it is running and only switch it off afterwards.

See also section 6.1 *Switch operation*.

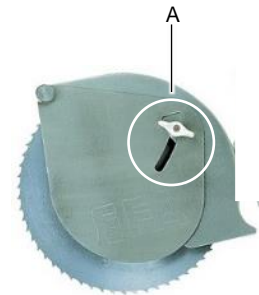

Fig. 6.3 – Depth of cut (depth stop)

### 6.2.2 Operational safety

For safety reasons, EFA circular saws must be held with two handles.

Never work one-handed.

- Do not carry the saw by the switching handle, it could start unintentionally.
- Be especially careful when switched on.
- Do not remove the protective devices from the saw for breaking carcasses.
- Never reach into the area of the saw blade when it is switched on.
- Never work if the run-down brake is defective.
- After switching off, the saw blade comes to a standstill within 3 s due to the run-down brake. Only then release the handles.
- For safer handling (guiding), the saw must be suspended from a spring balancer, see section 5.1.1 *Spring balancer*.
- Regularly check the suspension for damage.
- Observe general safety regulations, see chapter 2 – *Safety*.

**EFA SK 40 E**

- Activate the switch-on safety device overnight, see section 6.1.1 *Switching on*:

**Rest position = OFF** mark at **red** dot.

**Ready = ON** mark at **red** dot.

# 7 Assembly

**Danger!**



**Assembly work is only allowed to be carried out by authorised specialist personnel.**

**Danger!**



**Voltage!**  
**Disconnect the device from the mains prior to performing any assembly work!**

**Warning!**



Wear cut-resistant gloves and safety shoes during all assembly work.

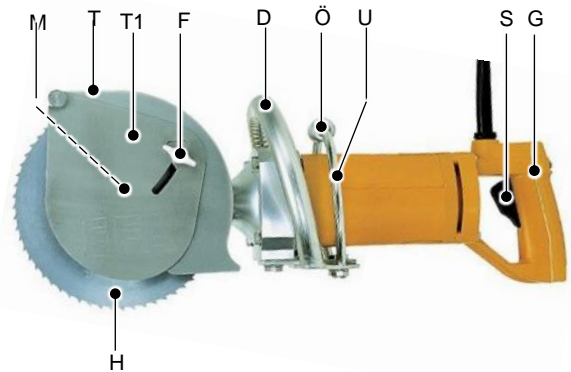

Fig. 7.1 – Saw blade change

## 7.1 Saw blade change

**Danger!**



**Never reach into the cutting area of the running saw blade, otherwise you could cut off limbs!**

**Important!**



Only use genuine EFA saw blades!

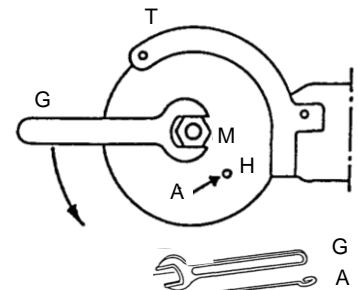

Fig. 7.2 – Loosening the saw blade

### Removal of saw blade

- 1) **EFA 86, EFA 186 and EFA SK 23/18**  
Unscrew wing nut (F) and remove depth stop (T1), see Fig. 7.1.
- 1) **EFA SK 40 E**  
Switch-on safety device (D) in rest position (OFF mark at red dot), see Fig. 6.1 Switch operation.
- 2) Insert the retention pin (A) into the hole in the saw blade (H) and turn it with the saw blade against the protective hood (T). Place open-end wrench (G) on hexagon clamping nut (M) and open in the direction shown, see Fig. 7.2.
- 3) Carefully remove the hexagon clamping nut (M) and the saw blade.

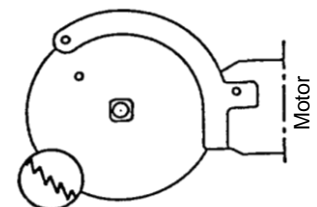

Fig. 7.3 – Direction of blade teeth

### Installation of saw blade

- 1) Place the saw blade ready for use on the square holding fixture; the teeth must point towards the motor on the underside, see Fig. 7.3.
- 2) Insert the retention pin (A) into the hole in the saw blade (H) and turn it with the saw blade against the protective hood (T). Place open-end wrench (G) on hexagon clamping nut (M) and clamp tightly in the direction shown (tightening torque: 50 Nm). Do not tighten the hexagon clamping nut with excessive force.
- 2) **EFA SK 40 E**  
Switch-on safety device in ready position (ON mark at red dot).
- 3) Remove retention pin (A) and open-end wrench (G) and perform test run.

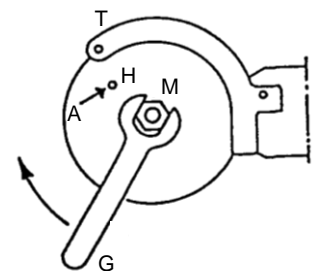

Fig. 7.4 – Fixing the saw blade



## 7.2 Sharpening the saw blade

We have established a sharpening service in our Service department.

Incorrectly resharpened saw blades result in production losses or a considerable hazard for the user.

Sharpening can also be carried out on commercially available automatic saw blade sharpening machines.

The following tables and *Fig. 7.5 – Saw blades* provide an overview of our range of saw blades.

## 7.3 Protective hood and depth stop

The depth of cut can be adjusted with adjustable depth stop or protective hood.

### Protective hood -H-

All machines are equipped with an adjustable protective hood (H), see *Fig. 7.6*.

Adjust it for the desired use as follows:

- 1) Remove the saw blade, see *section 7.1 Saw blade change*.
- 2) Remove the two hexagon screws.
- 3) Depending on the depth of cut, select the mounting holes of the protective hood, see *Fig. 7.6*.
- 4) Screw the protective hood back on with the two hexagon screws.
- 5) Reinstall the saw blade, see *section 7.1 Saw blade change*.

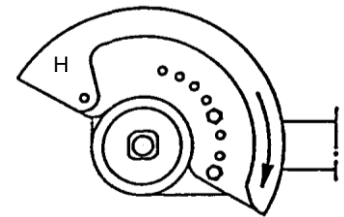

*Fig. 7.6 – Setting the protective hood*

### Depth stop -T- (EFA 186, EFA 86, EFA SK 18 and EFA SK 23/18)

These machines are equipped with an adjustable depth stop (T), see *Fig. 7.7*.

Set this for the desired use as follows:

1. Loosen the wing nut (F).
2. Swivel the keep-off rail (T) over the pivot point (X).
3. Tighten the wing nut (F).

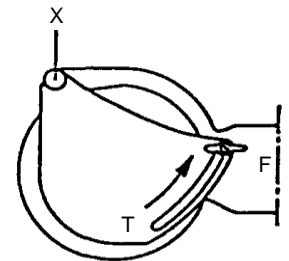

*Fig. 7.7 – Setting the depth stop*

## 7.4 Changing the carbon brush (EFA SK 18 WB, EFA SK 23/18, EFA SK 30/18)

When the carbon brushes are worn down, the automatic switch-off interrupts the power supply and the machine stops. The automatic function prevents the armature collector from being damaged by the brush spring.

There is no need for constant monitoring.

### Attention!



**Disconnect the saw from the mains.**

**The carbon brushes are only allowed to be replaced in pairs.**

When replacing the carbon with automatic feed, the connection must be laid as a loop, see *Fig. 7.8*.

After at least every second carbon change, the cavities between the armature, see *Fig. 7.9*, must be brushed through with a plastic brush.

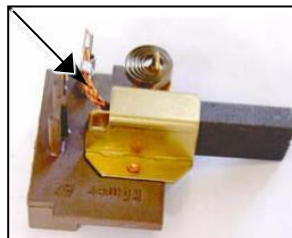

*Fig. 7.8 – Carbon brush*



*Fig. 7.9 – Armature*



## 8 Cleaning

**Danger!**



**Voltage!**

**Only carry out cleaning work when the device is disconnected from the mains.**

**Danger!**



**Observe the safety and hygiene requirements!**

### 8.1 Daily cleaning after completion of the slaughtering

Trouble-free continuous operation can only be guaranteed if the EFA circular saw is kept perfectly and hygienically clean at all times.



Also observe the safety instructions in the product data sheets of the cleaning agents.

Disinfectants must not come into direct or indirect contact with foodstuffs. Therefore, rinse the device with clear water after disinfection.



Do not use any aggressive solvents!  
Do not use a steam blaster or high-pressure cleaner! Do not immerse the device in water!

Disinfect the device with hot water (82 °C) after each cut during operation.

#### 8.1.1 Cleaning the circular saw

**Warning!**



**Cutting hazard!**

Wear cut-resistant gloves and safety shoes when cleaning the circular saw.

For cleaning the device after work:

- Bring the circular saw to your tool point (workshop).
- Remove coarse dirt with a brush and hot water (approx. 45 – 55 °C); tenacious or crusted residues must be soaked in order to be able to remove them.
- Put a cleaning agent in hot water. Spread the solution over the surfaces to be cleaned and allow the cleaning agent to work for 15 – 20 minutes.
- Wash off the dissolved dirt with hot water.
- Wash and dry the entire circular saw with clean water.

Cleaning must be carried out outside the breaking hall in the maintenance room, remove the saw blade here, see section 7.1 – *Saw blade change*.

## 9 Maintenance and repair

### 9.1 Maintenance

**Note**



Observe all safety instructions.

**Danger!**



Maintenance work is only allowed to be carried out by qualified and instructed personnel.

**Warning!**



**Cutting hazard!**  
**Before carrying out any maintenance work, switch off the device and disconnect it from the mains!**

#### 9.1.1 Daily maintenance of the circular saw

To ensure the longest possible service life and low wear and tear, the circular saw must be checked and serviced regularly.

Service and maintenance work must only be carried out by instructed personnel.

Only use genuine EFA spare parts or spare parts recommended by **Schmid & Wezel GmbH** Maschinenfabrik.

**Saw blade**

Remove the device from the breaking hall and take it to the maintenance location or workshop to remove the saw blade there.

Regularly check the saw blade. If the self-locking of the hexagon nut is no longer guaranteed, it must be renewed immediately.

#### 9.1.2 Extended maintenance (after approx. 50 operating hours)

**Lubrication**

To ensure the lubrication of the ball bearings and the gear unit, the machine must be greased using a grease gun with 3 strokes at each grease nipple (X).

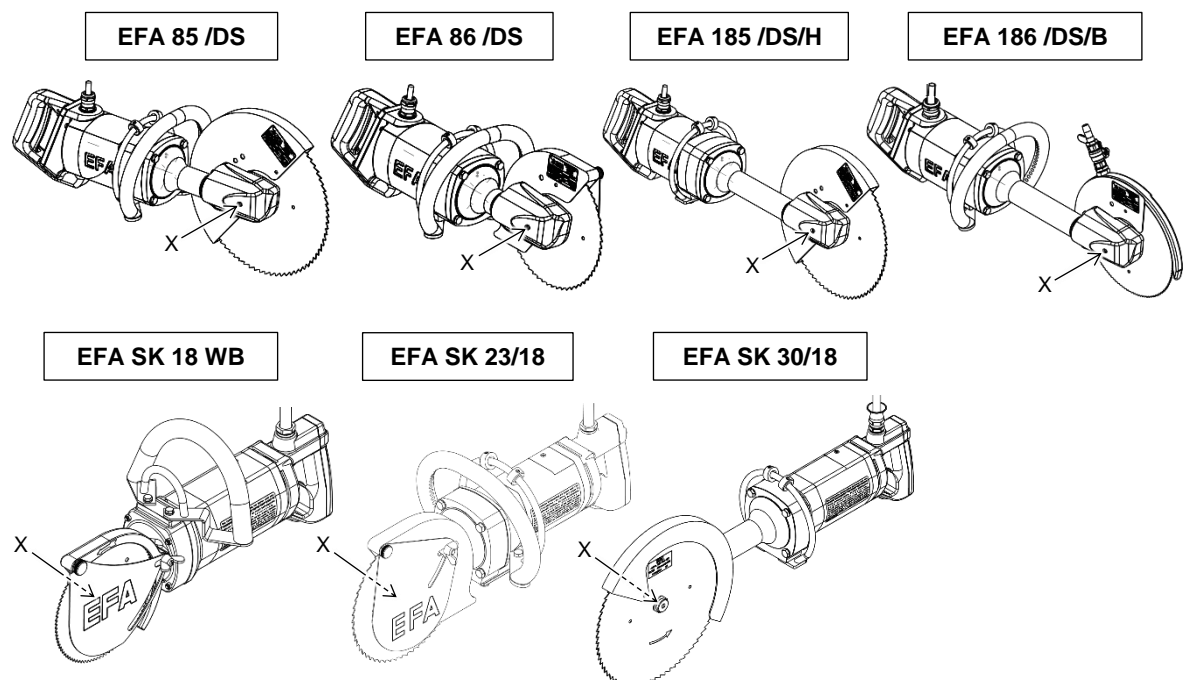

**Brake**

If the brake malfunctions, it must be checked and possibly replaced for safety reasons. If the run-on times are longer than 3 s, the brake must be repaired without fail.

**Sharpening the saw blade**

Remove the device from the breaking hall and take it to the maintenance location or workshop to remove the saw blade there.

Incorrectly resharpened saw blades result in production losses or a considerable hazard for the user.

**Note**



We have established a sharpening service for you in our Service department. Please contact the nearest authorised service centre or our head office in this case.

**Danger!**



**Do not use force, as parts could be damaged! Only use genuine EFA spare parts.**

## 9.2 Repair by customer service

**Danger!**



**Repairs are only allowed to be carried out by qualified and instructed personnel.**

**Danger!**



Only use genuine EFA spare parts.

**Danger!**



**Voltage! Disconnect the circular saw from the mains prior to performing any repair work.**

- The **EFA Service department of Schmid & Wezel GmbH** is at your disposal for repairs. If your equipment needs to be repaired, please contact the nearest authorised service centre or our head office.
- After repairs, the fill-for-life lubrication of the gear units must be restored each time!
- In the event of malfunctions that cannot be clearly localised, the device should be returned to **S&W** for repair.

### 9.2.1 Return

Return your waste electrical equipment to our head office.

**Schmid & Wezel GmbH**

**Maschinenfabrik**

Maybachstrasse 2

75433 Maulbronn / Germany

☎ +49 7043 / 1020

☎ +49 7043 / 10278

@ [efa-verkauf@efa-germany.de](mailto:efa-verkauf@efa-germany.de)

Internet: <http://www.efa-germany.de>

## 10 Waste disposal – recycling

The machine must be disposed of in accordance with the valid legal regulations of the respective countries.

### **Disassembly and disposal**



Old and used machines contain reusable materials that can be recycled.

During disposal, it is essential to observe regional and local environmental protection regulations.

- 1) Disconnect the machine from the mains power and/or the pneumatic/hydraulic supply.
  - 2) Disassemble the machine completely.
  - 3) Degrease the machine completely.
  - 4) Dispose of used oil and components and materials contaminated with oil in accordance with the applicable environmental conditions.
  - 5) Separate all reusable materials according to type.
  - 6) Sort the individual reusable materials for recycling and disposal.
  - 7) Dispose of the hazardous waste at a local hazardous waste disposal site.
- Or
- 8) Return your waste electrical equipment to our head office.



**Schmid & Wezel GmbH**  
**Maschinenfabrik**

Maybachstrasse 2  
75433 Maulbronn / Germany

☎ +49 7043 1020

☎ +49 7043 10278

@ [efa-verkauf@efa-germany.de](mailto:efa-verkauf@efa-germany.de)

Internet: <http://www.efa-germany.de>